

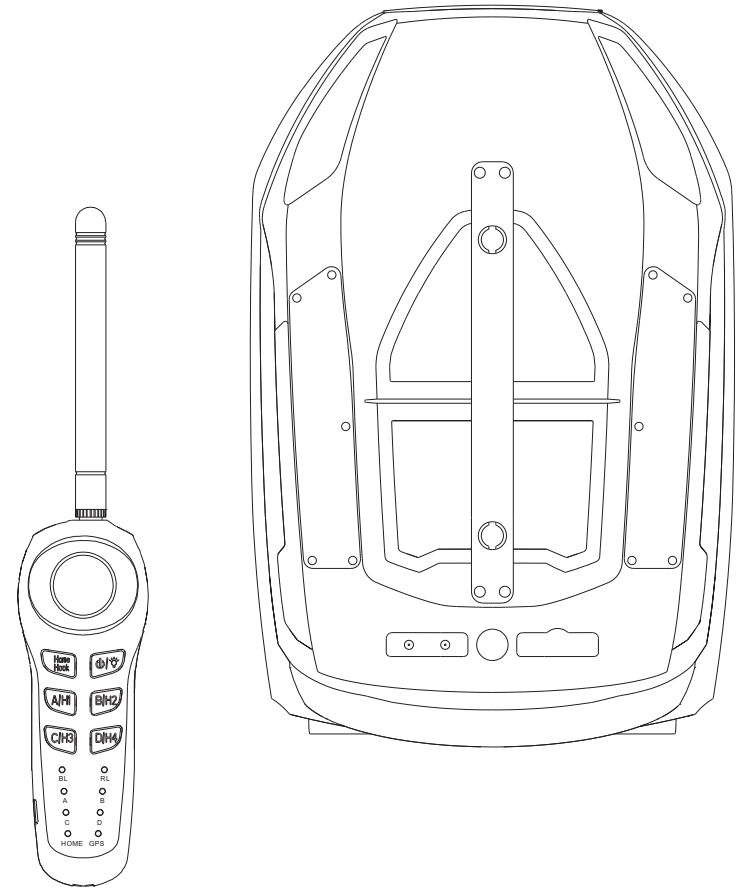

# User Manual

Newdirectiontackle.co.uk



**ND TACKLE**

Email: [Info@NewDirectionTackle.co.uk](mailto:Info@NewDirectionTackle.co.uk)



### Thank you for buying your BlueTooth Bait boat.

Outstanding performance and reliability have made ND Tackle bait boats amongst the most popular in the world. Designed by leading anglers in conjunction with engineers and technicians, there's a bait boat in the ND Tackle range to answer all of your baiting, rig placement and others needs.

Please take the time to read and understand this manual. Your ND Tackle Bait Boat will deliver years of trouble-free usage when used and maintained correctly.



## BLUETOOTH ND Tackle Bait Boat CATALOGUE

- 1 What you get with Your ND Tackle bait boat
- 2 Specifications
- 3 Features
- 4 Overview
- 5 How to assemble the Mainframe with Floater
- 6 Charging and battery maintenance
- 7 Using your ND tackle bait boat
- 8 Tips
- 9 Support
- 10 Guarantee

# ND TACKLE

ND Tackle's policy is one of continuous improvement and we reserve the right to change product specifications without prior notice. Illustrations are for guidance purposes only.

# 1 | What you get with Your ND Tackle bait boat

Your ND tackle bait boat contains the following items as standard:

- |                                      |                       |
|--------------------------------------|-----------------------|
| 1) Mainframe                         | 1pc                   |
| 2) Small Floater                     | 2 pcs                 |
| 3) Extension hopper                  | 1 pc                  |
| 4) Mini Handset                      | 1pc(includes battery) |
| 5) 14.8V 7.5A Li-Ion battery         | 2pcs                  |
| 6) 16V 3A home charger for bait boat | 1pcs                  |
| 7) USB cable                         | 1pc                   |
| 8) Antenna for bait boat             | 1pc                   |
| 9) Large Deluxe Bait boat bag        | 1pc                   |
| 10) User manual                      | 1pc                   |

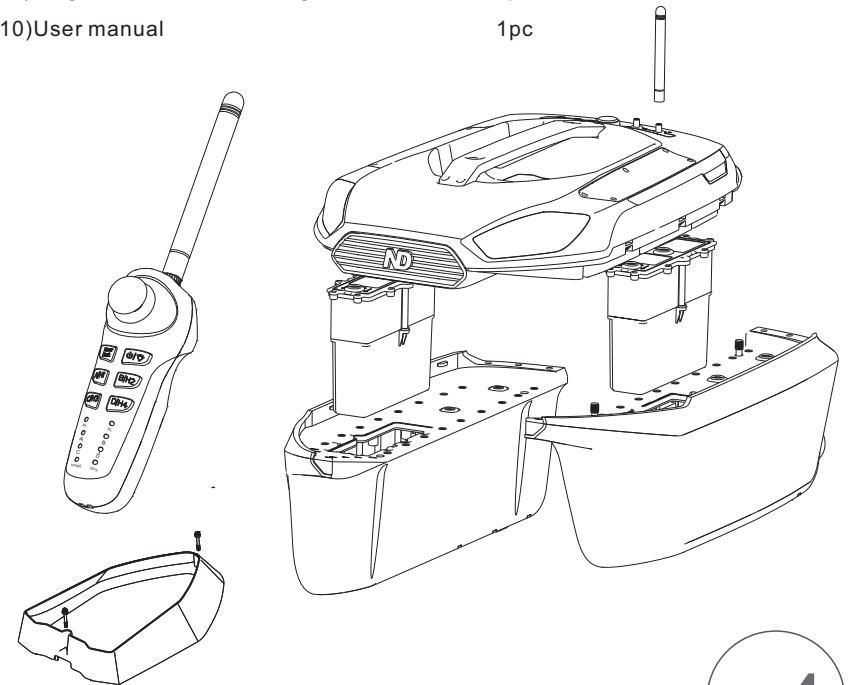

# 2 | Specifications

## Product Model: ND tackle Bait Boat

Dimensions: H24cm\*W40cm\*L56cm

Weight: 7.5kgs

Outfit: 2 independent hoppers, 1 independent hook release

Bait Capacity: 3kgs ( 1.5kgs per hopper )

Boat batteries: Li-Ion 14.8V\*15A

Boat Lights: 2 front , 2 side , 2 rear

Propulsion: 2 High performance industrial engines

External Interface: 2\*USB, 1\*DC-in-out Jack

Radio frequency: 2.4GHz

Range: 300m +/- dependant on weather and environmental conditions

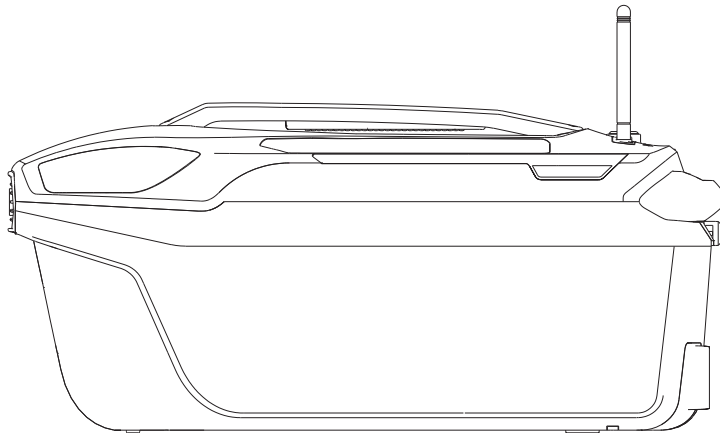

# 3 | Features



## Autopilot

Full Self-Driving Hardware on ND Tackle bait boat.



## Full-Featured APP

Navigation with maps and real time positional information of ND bait boat.



APPLE STORE



Google Play



## Unique LIGHTING system

Head lights, Body lights and Tail lights. Light indicator system can help you to distinguish the driving direction of boat which is helpful when driving at distance.



## Easily Detachable Parts

Floater \* 2 and Mainframe\*1. Modular design can be easy to maintain.



## Mini handset ( Transmitter Controls )

Transmission range of up to 300M on free sight, free of interference, when FCC compliant.



## WORRY-FREE System

It will come back automatically when the battery runs at Low power or the wireless signal is lost.



## Longest battery lifetime.

6.2 miles Range per charge.



## Easy to Update Firmware

SD card sockets can help you to upgrade software to ND bait boat easily.

# 4 | Overview

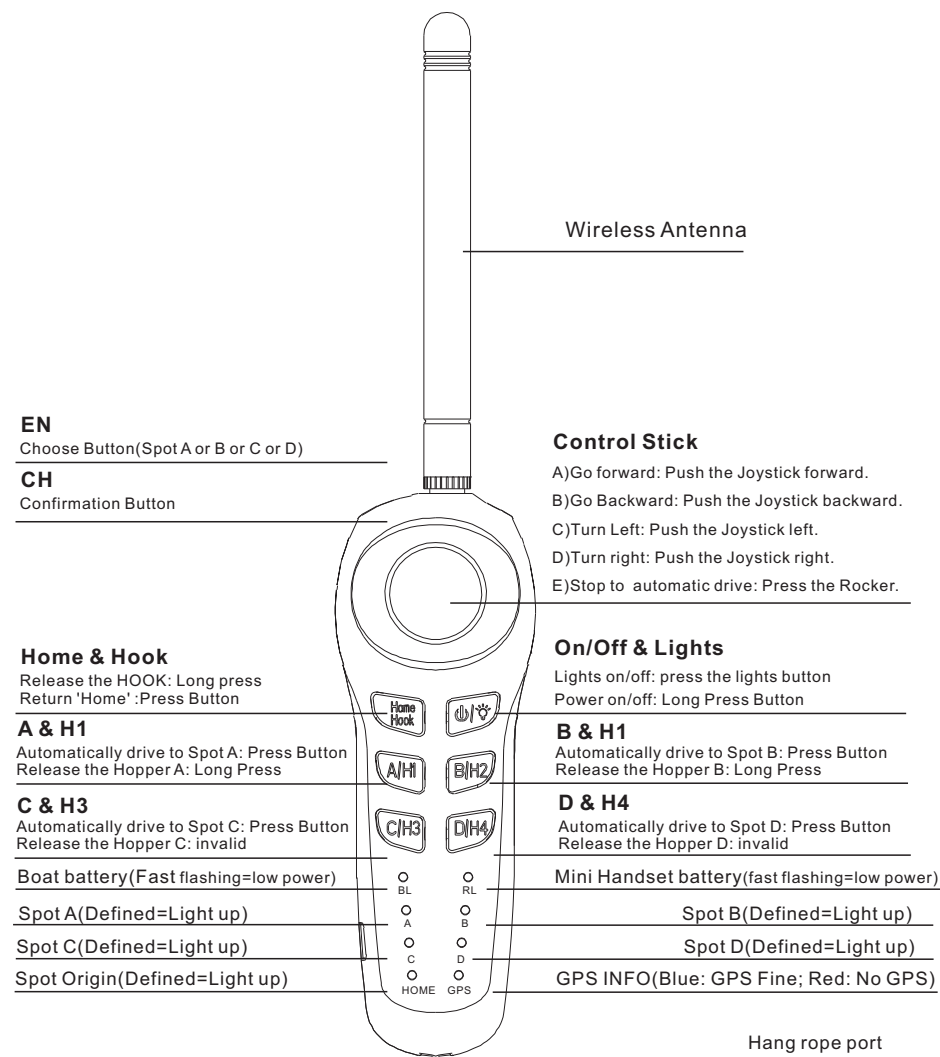
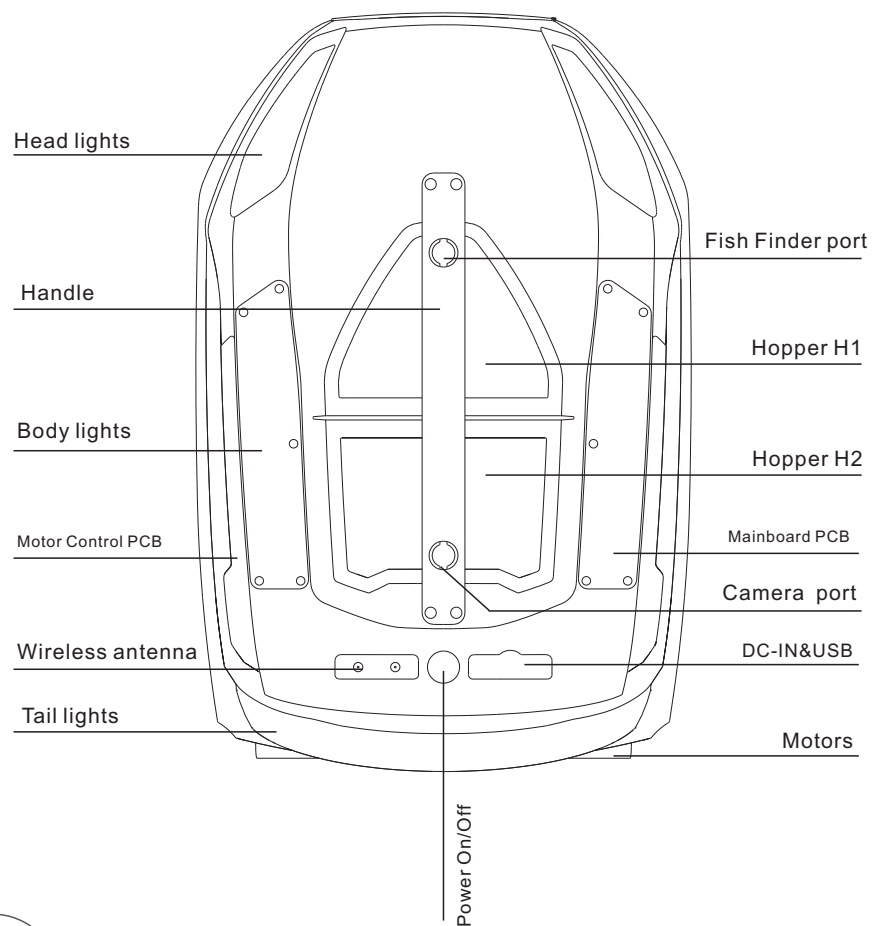

**NOTE:**

- 1) MINI HANDSET IS NOT WATERPROOF, PLEASE KEEP OUT OF CONTACT WITH WATER.
- 2) The mini handset will automatically shut off after 60 minutes of not being used, to help preserve battery life.

## 5 | How to assemble the Mainframe with Floater

A) Align the bump buckle on the side of the Floater

B) Lock the two screws with the mainframe

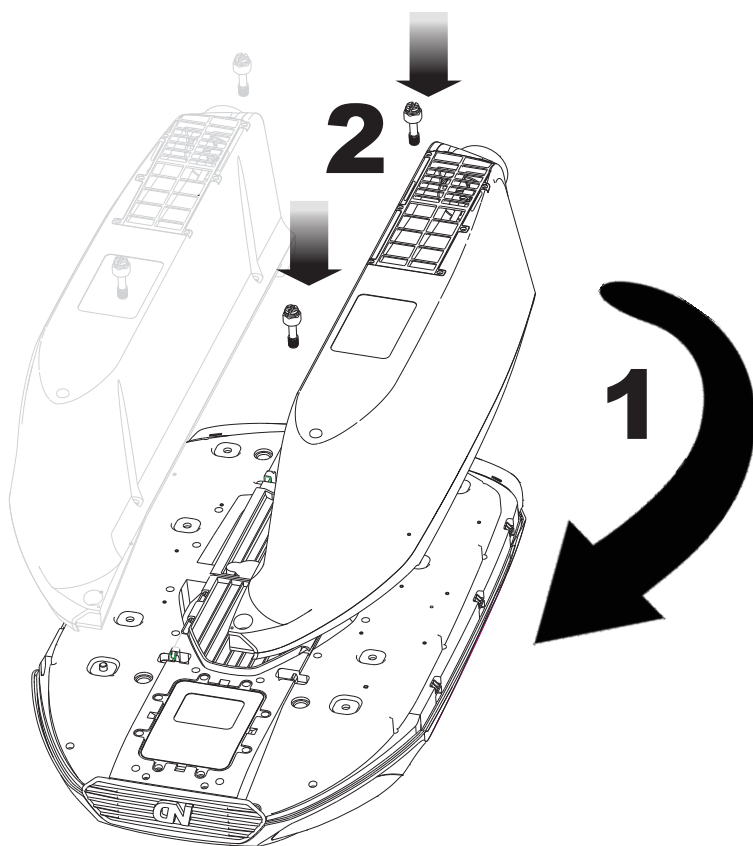

## 6 | Charging and Battery Maintenance

A) Charging the boat battery

Charger parameters:

GREEN: Full

RED: Charging

Output : 14.8V/3A

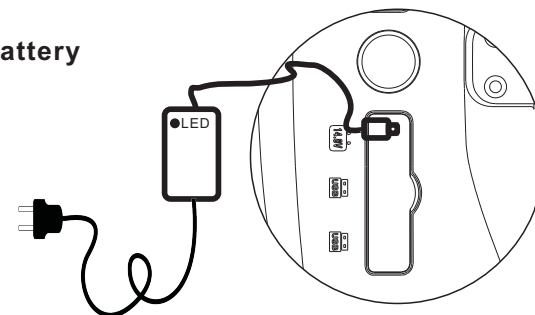

B) Charging the mini Handset battery

You can use the USB(Micro B) with Smart phone charger to charging the mini Handset.

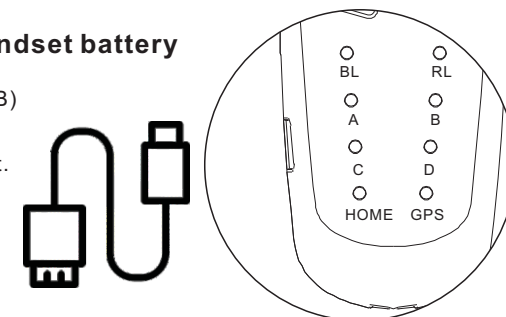

- To ensure trouble-free charging, only use the chargers supplied by ND tackle.
- First charge of a new battery to fully charged will take approximately 6 hours.
- Please note that both batteries must be charged together.
- You can charge your batteries directly, without taking it out of the boat, via the charging socket on the rear of the boat. Please be sure the power switch is OFF.
- After use ensure all batteries are fully charged before you pack the boat away for the next trip. If the boat is not going to be used for some months then recharge the batteries every 2-3 months.

# 7 | Using Your ND Tackle Bait Boat

**A) Connect the Antennas.**

**B) Turn on the mini handset.**

Long press 'On/Off'

**C) Turn on the Bait Boat.**

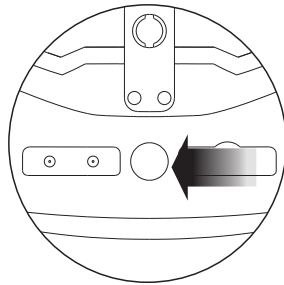

**D) Place the boat in the water (no waves).**

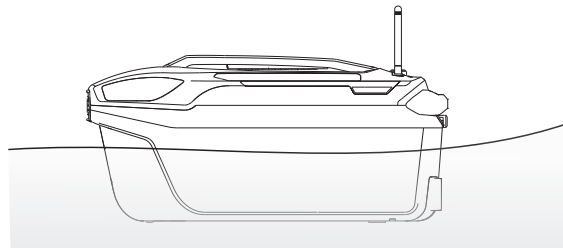

**E) Calibrating the compass on bait boat (important!!!)**

Long press 'CH'+ 'EN' on the mini handset

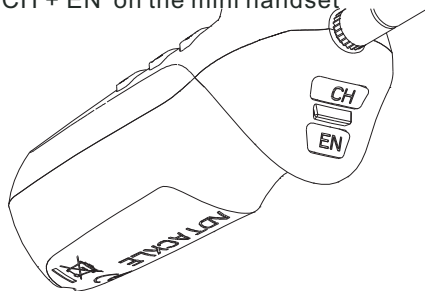

# 8 | Tips



**How Register the mini handset with Bait Boat**

**If the Mini handset fails to control the boat, please re register**

A) Turn on The mini Handset

B) Long Press the control stick on the handset

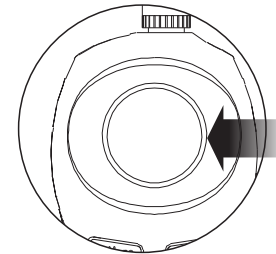

C) The GPS light on the Handset will flash

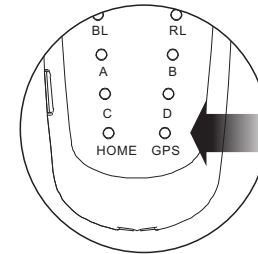

D) Turn on the Bait boat

E) Wait 4 seconds for the GPS light to stop flashing, once flashing has stopped boat and handset are registered

F) If this has not worked please repeat steps A-E



## How use autopilot with mini handset

When using the autopilot, Don't forget to Calibrating the compass of bait boat.

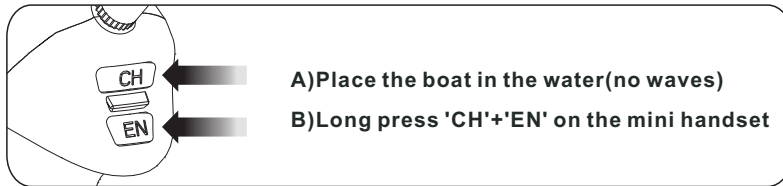

### A) Define the Spot 'HOME'

Long press 'CH' Button on the mini Handset to define the Spot 'HOME'.  
The HOME light will be up when success.

### B) Drive the boat to distant

### C) Press 'CH' to choose the spot A or B or C or D

### D) Press 'EN' to confirm the spot.

The light will up when success.

### E) Test the Autopilot

Press 'H' to bring ND Bait boat safely home.  
Press 'A' Auto navigate to spot A.

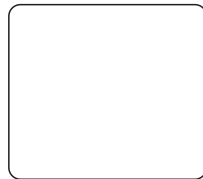
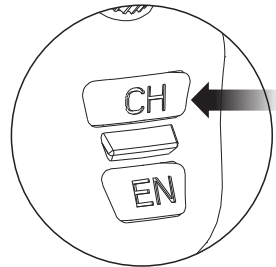

VIDEO



## How use autopilot with APP

When using the autopilot on the APP(ND Bait Boat),  
Please download the APP on the Apple store or Google Play.



APPLE STORE



Google Play

### A) Turn on the mini handset and ND Bait boat

### B) Click the 'ND Bait boat' APP on your Smart Phone

### C) Define the spot 'HOME'. Long touch on the Map, Press the Home button.

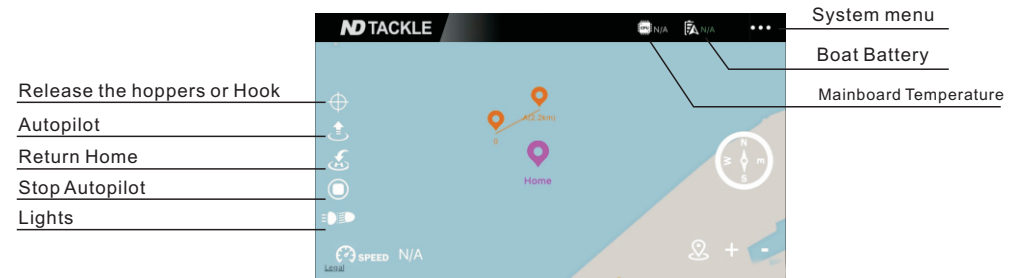

### D) Define the Spot A

Long touch on the Map, Press the Save button.

### E) Test the Autopilot on the APP

Press 'Return Home' Button to back home  
Press 'Autopilot' button on the APP and choose A to Spot A

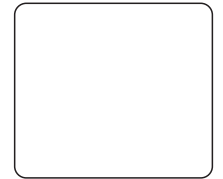

VIDEO





## Smart Return Home

Use the 'H' button on the Mini handset or tap the 'Return Home' button in the ND tackle bait boat app and follow the on-screen instructions when GPS is available to initiate Smart Return Home.

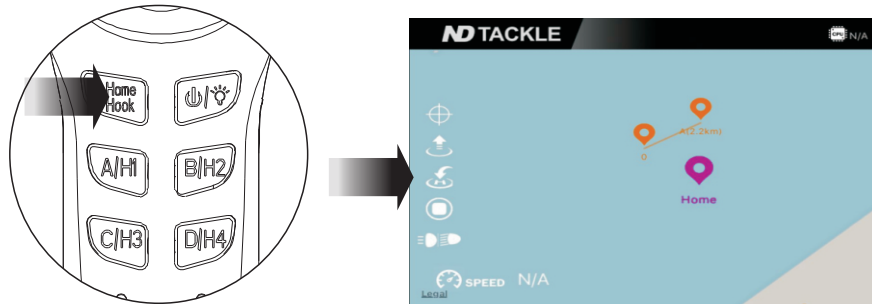

The Boat will then automatically return to the last recorded Home Point. Use the Mini handset to control the boat direction to avoid a collision during the Smart Return Home process.

**If the Boat loses the wireless connection, it will trigger the 'Return Home' command automatically.**

The user can cancel the Return Home procedure by pressing the 'Control stick' on the mini handset or 'Stop' button on the APP.

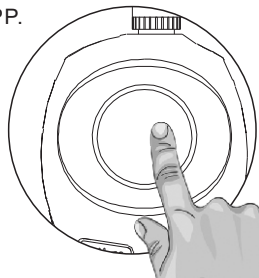

## Turn On/Off the lights on the boat

**Unique Lights system** can help you to distinguish the driving direction of ND Bait Boat which is helpful when driving at distance.

Turn On/Off lights on the boat: Press '☾' Button.

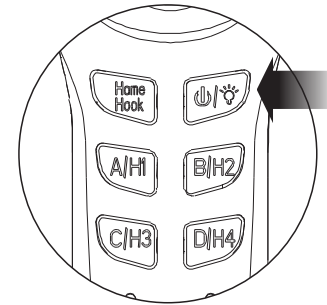

## Upgrading the Firmware

**Use SD card to upgrade your ND tackle Bait Boat.**

1. Power Off the boat
2. Download the file on the [NewDirectionTackle.co.uk](http://NewDirectionTackle.co.uk) website
3. Copy the file to SD card(Root directory), rename to 'test.bin'
4. Please put the SD card into the SD slot on the boat
5. Power on the boat
6. Wait approximately 60 seconds and the boat will restart.



## How to attach the Fish Finder and Camera to the Boat

ND Tackle Bait Boat includes two ports for Fish Finder and a camera on the handle. You can buy a connecting bracket for them, It is simple to attach.

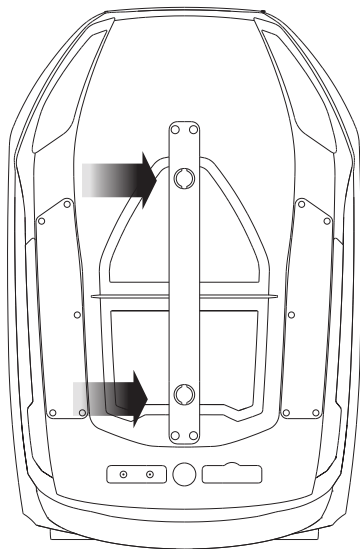
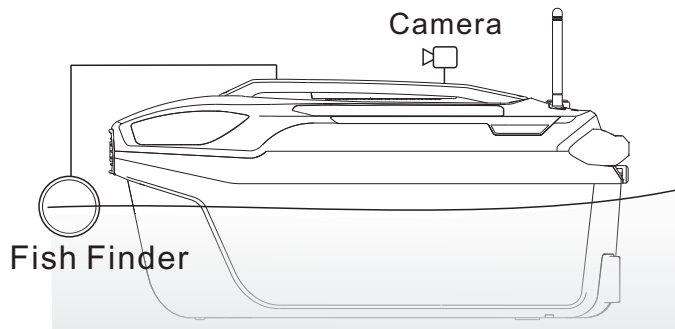

## How to identify the fault

### Bootstrapping Hardware FAULT INFORMATION

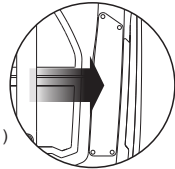
Message	Solution
All lights flashing on the boat	<p>Open the case on the right side of Boat, you will find the information on the screen.</p> <ol style="list-style-type: none"> <li>1)No Wireless. (Re-Register , see page 12)</li> <li>2)No GPS. ( please take boat to open air destination)</li> <li>3)No Compass. (Contact ND tackle Support, see page 21)</li> </ol> 

### Warning Message on the mini handset or boat

Message	Solution
One Beep	<p>Low power, Charge the boat battery, see page 10</p> 
Two Beeps	Wireless signal Loses , Please Re-Register, see page 12
Three Beeps	GPS signal loses, please take boat to open air destination



## How to open the Hoppers or Hook release

The boat includes two hoppers, You can navigate to the desired destination and release by yourself.

### Release the Hopper-H1: Long Press 'H1' Button.

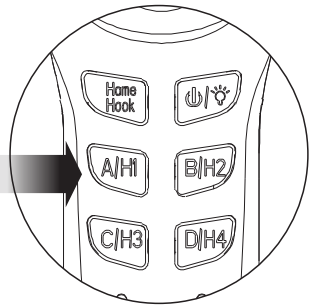

### Release the Hopper-H2: Long Press 'H2' Button.

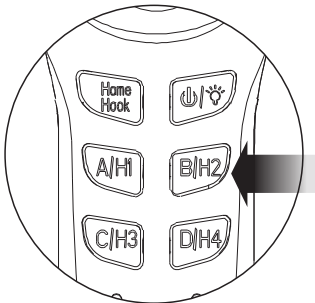

### Notes

- Always turn the Mini handset on first and then the boat. To turn off, turn off the boat first and then the Mini handset, This will ensure that you are always in control of the boat.
- The Mini handset should be protected from water at all times.
- Keep the jack cover on the bait boat when it goes into the water.
- Store your boat and Mini handset in a warm, dry place when not in use, in order to prevent condensation build up.
- It is recommended that the bait boat be cleaned with a damp cloth after use.
- After use ensure all batteries are fully charged before you pack the boat away for the next trip.
- If the boat is not going to be used for some months then recharge the batteries every 2-3 months.
- Please disconnect the boat antenna and Mini handset antenna after use to avoid breakage.
- Clean the bait boat with a slightly damp cloth. Do not use soap or solvent.
- The range of the boat is dependant on weather and environmental conditions.



### Environmentally friendly disposal

Old electrical appliances must not be disposed of together with the residual waste, but have to be disposed of separately.

The disposal at the communal collecting point via private persons is for free. The owner of old appliances is responsible to bring the appliances to these collecting points or to similar collection points. With this little personal effort, you contribute to recycle valuable raw materials and the treatment of toxic substances.

# 9 | Support

## Newdirectiontackle.co.uk/support/

We are committed to providing you with the best possible products and services, but in the unfortunate circumstance that you have a complaint or our app has a bug which needs to be fixed, please get in touch with us straight away using our support center system.

In order to streamline support requests and better serve you, we utilize a support ticket system. Every support request is assigned a unique ticket number which you can use to track the progress and responses online. For your reference we provide complete archives and history of all your support requests. A valid email address is required to submit a ticket.



### Tell us what you think...

To maintain quality and product development New Direction has listened to the voices of its customers and identified their specific requirements and preferences. The company has designed and produced a range of exciting products for with our vision of becoming the most popular brand available.

**New Direction Tackle UK team:** [info@NewdirectionTackle.co.uk](mailto:info@NewdirectionTackle.co.uk)

**New Direction Tackle DE team:** [Info@NewDirectionTackle.de](mailto:Info@NewDirectionTackle.de)

**New Direction Tackle NL team:** [Info@NewDirectionTackle.nl](mailto:Info@NewDirectionTackle.nl)

# 10 | Guarantee

## Newdirectiontackle.co.uk/guarantee/

We offer you a 24 months guarantee from the date of purchase.

The guarantee covers any defects arising from the drive unit and the electrical and electronic parts of the boat, faulty material and workmanship.

It does not cover batteries, damage arising from improper use, breakage, or normal wear of the boat or associated equipment.

The guarantee is invalidated if repairs or modifications are undertaken by unauthorized persons.

The guarantee period for the rechargeable battery and the rechargeable LI-ION batteries is 6 months from the date of purchase.

Please complete the form to register your ND tackle Warranty on [NewDirectionTackle.co.uk/guarantee](http://NewDirectionTackle.co.uk/guarantee)

NAME

---

ADDRESS

---

---

POST CODE

---

TELEPHONE NUMBER

---

EMAIL ADDRESS

---

ORDER NUMBER

---

SERIAL NUMBER

---

\*Found it under the boat lid facing forward on a white sticker